

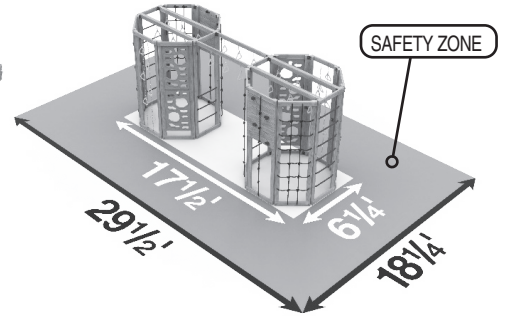

CLIFFHANGER™

Safety Guide & Assembly Instructions Guide de sécurité et Instructions de montage Directrices de Seguridad e Instrucciones de Construcción



(Gold Design Option requires additional kit*)

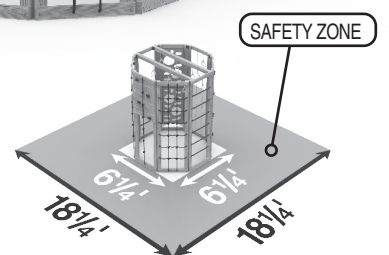
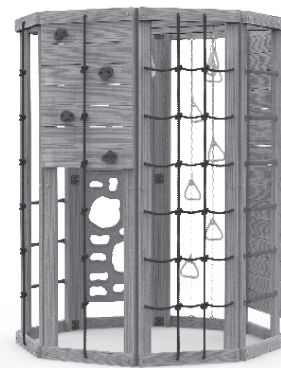
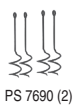
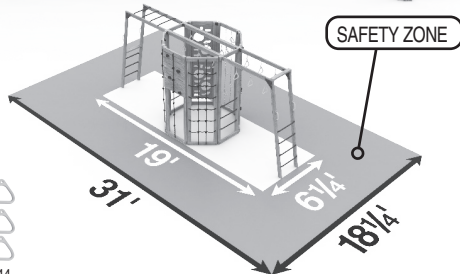
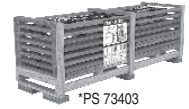

We Will Gladly Help! • ¡Le Ayudaremos Con Mucho Gusto! • C'est avec joie que nous vous aiderons!

1-888-PLAYSTAR
(752-9782)

Monday through Friday, 8:00 A.M. to 5:00 P.M. C.S.T.
 De Lunes a Viernes de 8:00 A.M. a 5:00 P.M. C.S.T.

(450) 699-3083

Du lundi au vendredi, de 8 h à 16 h EST

www.playstarinc.com

SAFETY

- This product is intended for single-family residential use only, by children ages two to ten and a maximum weight of 105 pounds. Any recommendation over 10 years of age or 105 pounds exceeds the upper limits specified in the American Society for Testing and Materials (ASTM) Home Playground Safety Standard. In order for PlayStar to comply with the ASTM Standard, we cannot recommend anyone above these limits.
- It is a misuse of this product when installed or used in places of public assembly such as schools or parks.
- Follow the instructions provided, do not alter its design in any way.
- Construction requires at least two adults capable of heavy lifting.
- Thoroughly read all safety instructions before beginning.
- Children must remain clear of construction site until this product is properly installed and ready for use.
- Save these instructions in the event the manufacturer has to be contacted.

The Consumer Product Safety Commission provides the following consumer information for your Home Playground Equipment

Select Protective Surfacing

One of the most important things you can do to reduce the likelihood of serious head injuries is to install shock-absorbing protective surfacing under and around your play equipment. The protective surfacing should be applied to a depth that is suitable for the equipment height in accordance with ASTM F1292. There are different types of surfacing to choose from; whichever product you select, follow these guidelines:

NOTE: Do not install home playground equipment over concrete, asphalt, packed earth, grass, carpet or any other hard surface. A fall onto a hard surface can result in serious injury or death to the equipment user. Grass and dirt are not considered protective surfacing because wear and environmental factors can reduce their shock absorbing effectiveness. Carpeting and thin mats are generally not adequate protective surfacing. Ground level equipment -- such as a sandbox, activity wall, playhouse or other equipment that has no elevated play surface -- does not need any protective surfacing.

Loose-Fill Materials

PlayStar Playsets require fall-height protection from eight feet.

- Maintain a minimum depth of 9 inches of loose-fill materials such as wood mulch / chips, engineered wood fiber (EWF), or shredded/recycled rubber mulch for

equipment up to 8 feet high. NOTE: An initial fill level of 12 inches will compress to about a 9-inch depth of surfacing over time. The surfacing will also compact, displace, and settle, and should be periodically refilled to maintain at least a 9-inch depth.

- Use containment, such as digging out around the perimeter and/or lining the perimeter with landscape edging. Don't forget to account for water drainage.
- Check and maintain the depth of the loose-fill surfacing material. To maintain the right amount of loose-fill materials, mark the correct level on play equipment support posts. That way you can easily see when to replenish and/or redistribute the surfacing.
- **Do not** install loose fill surfacing over hard surfaces such as concrete or asphalt.

Poured-In-Place Surfaces or Pre-Manufactured Rubber Tiles

You may be interested in using surfacing other than loose-fill materials -- like rubber tiles or poured-in-place surfaces.

- Installations of these surfaces generally require a professional and are not "do-it-yourself" projects.
- Review surface specifications before purchasing this type of surfacing. Ask the installer/manufacturer for a report showing that the product has been tested to the following safety standard: ASTM F1292 *Standard Specification for Impact Attenuation of Surfacing Materials within the Use Zone of Playground Equipment*. This report should show the specific height for which the surface is intended to protect against serious head injury.

This height should be equal to or greater than the *fall height* - vertical distance between a designated play surface (*elevated surface for standing, sitting, or climbing*) and the protective surfacing below - of your play equipment.

- Check the protective surfacing frequently for wear.

Placement

Proper placement and maintenance of protective surfacing is essential. Be sure to;

- Extend surfacing at least 6 feet from the equipment in all directions.
- For to-fro swings, extend protective surfacing in front of and behind the swing to a distance equal to twice the height of the top bar from which the swing is suspended.

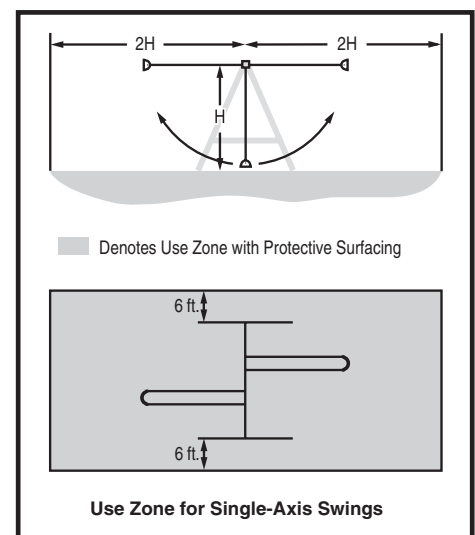

SAFETY

INSTALLATION:

1. Follow the instructions provided, do not alter its design in any way.
2. Place the equipment on level ground, not less than 6' (1.8m) from any structure or obstruction such as a fence, garage, house, overhanging branches, laundry lines or electrical wires. If the area where you will be installing your playset is not level, you must make it level.
3. Playsets must be anchored to the ground. Follow the anchoring instructions provided with your building kit. If soil conditions permit anchors to be pulled out easily, such as in sandy soil conditions, cementing is required.
4. Tighten all bolts securely to the intended member then cut off all protruding threaded ends of bolts with a hack saw **flush to the end of the nut** and remove sharp edges with a metal file.

WARNING: Children must not use the playset until properly installed and proper shock-absorbing surfacing material is in place.

OPERATION: Observing and following statements and warnings reduces the likelihood of serious or fatal injury.

1. On-site adult supervision is recommended for children of all ages.
2. Only one child, for each single planned

seat or single planned activity should be allowed on this set at one time, with a maximum weight of **105 pounds** for each child.

WARNING: You must teach children the following:

- A. **Not** to walk close to, in front of, behind, or between moving items.
 - B. **Not** to twist swing chains or ropes or loop them over the top support bar since this may reduce the strength of the chain or rope.
 - C. **Avoid** swinging empty seats.
 - D. **To Sit** in the center of the swings with their full weight on the seats.
 - E. **Not** to use the equipment in a manner other than intended.
 - F. **Not** to get off equipment while it is in motion.
 - G. **Not** to climb when equipment is wet.
 - H. **Not** to attach items to the playground equipment that are not specifically designed for use with the equipment such as, but not limited to, jump ropes, clothesline, pet leashes, cables and chain as they may cause a strangulation hazard.
1. **Remove** bike or other sports helmet before playing on the playground equipment.
 3. Verify that suspended climbing ropes are secured at both ends and that they cannot be looped back on themselves.
 4. Never add extra length to chain or rope.

The chains or ropes provided are the maximum length designed for the swinging element(s).

5. Dress children appropriately and do not allow them to wear inappropriate items, such as but not limited to, loose fitting clothing, hood and neck draw strings, scarves, cord-connected items, capes, and ponchos. These items can cause death by strangulation. Provide well-fitting and full enclosure footwear. Examples of inappropriate footwear are clogs, flip flops, and sandals.
6. Verify that all suspended swinging components have at least 8" clearance between the lowest point of component and top of shock-absorbing surfacing material.

WARNING: Lawn swings are designed for use by children two years of age and older. Use by children under the age of two can result in entrapment between the seat and backrest. **NEVER** place children in a rearward facing position or with legs between the seat and backrest because the child's body may pass through the opening causing entrapment of the child's head.

DISPOSAL:

When the playset is to be retired from service, disassemble and dispose of in such a way that no unreasonable hazards will exist. Follow your local disposal requirements.



ANNUAL MAINTENANCE CHECKLIST

(Copy this section as needed and maintain for your records or visit www.playstarinc.com/maintenance)

At the beginning of play season: Date: _____

- Tighten all hardware.
- Lubricate all metallic moving parts per manufacturer's instructions.
- Check all protective coverings on bolts, pipes, edges, and corners. Replace if they are loose, cracked, or missing.
- Check all moving parts including swing seats, ropes, cables, and chains for wear, rust, or other deterioration. Replace as needed.
- Check metal parts for rust. If found, sand and repaint using a non lead-based paint meeting the requirements of 16 CFR 1303.
- Check all wood members for deterioration and splinters. Sand down splinters and replace deteriorating wood members.
- Reinstall any plastic parts, such as swing seats or any other items that were removed for the cold season.
- Rake and check depth of loose fill protective surfacing materials to prevent compaction and to maintain appropriate depth. Replace as necessary.

Twice a month during play season: Date: _____

- Tighten all hardware.
- Check all protective coverings on bolts, pipes, edges, and corners. Replace if they are loose, cracked, or missing.
- Rake and check depth of loose fill protective surfacing materials to prevent compaction and to maintain appropriate depth. Replace as necessary.

Once a month during play season: Date: _____

- Lubricate all metallic moving parts per manufacturer's instructions.
- Check all moving parts including swing seats, ropes, cables, and chains for wear, rust, or other deterioration. Replace as needed.

At the end of each play season or when the temperature drops below 0° F: Date: _____

- Remove plastic swing seats and other items as specified by the manufacturer and take indoors or do not use.
- Rake and check depth of loose fill protective surfacing materials to prevent compaction and to maintain appropriate depth. Replace as necessary.

Owner shall be responsible for maintaining the legibility of any warning labels. If any of these conditions exist, call 1-888-752-9782 for ordering information.
Clean plastic components with warm water and a mild detergent such as dish soap.

Icon Glossary

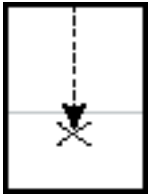

Place tower or component in desired location.

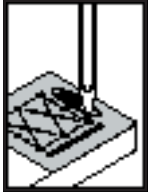

Mark board with template using pattern shown on this step.

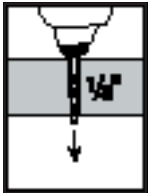

Drill through board at correct location with bit size shown.

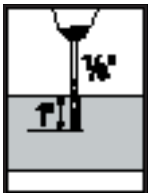

Drill down the depth shown into board at correct locations using bit size shown.
Note: You may use any bracket as a drill template.

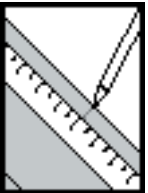

Mark board with measurement shown for location on this step.

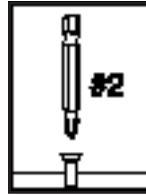

Secure screw (flush to top) with bit size shown.



Secure hardware with socket/wrench size shown.

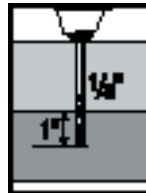

Pre-drill into second board with correct depth and bit size shown.
Note: Use pre-drilled board as template.



Screw hardware into board or ground using shaft of screwdriver for better leverage.

Helpful Hints



Make sure boards remain square.
Note: Assembly process should take place on flat surface.



This note helps with assembly process.



Do not _____.

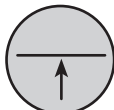

Be sure boards are flush.



Be sure boards/brackets are tight against each other.

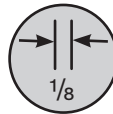

Be sure boards/components are spaced the distance listed.

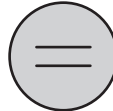

Be sure to equally space.



Be sure boards rest on the ground.

Icons are used throughout instructions to indicate process and information for each step.

Safety Warnings

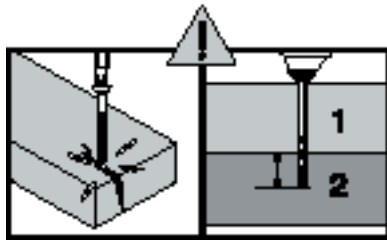

CAUTION: These boards should be pre-drilled to avoid cracking. **Note: Pre-drill into second board using first board as a template before attaching.**

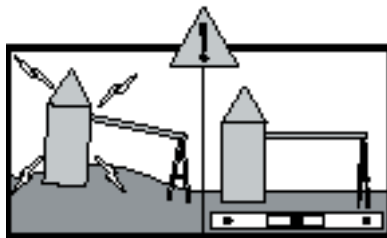

CAUTION: Ground must be level. Installation on a hill or incline will create unsafe conditions.

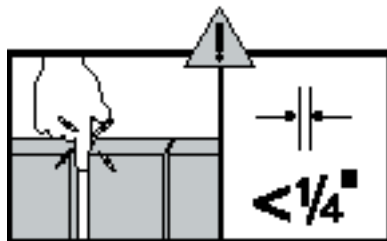

CAUTION: Spacing between boards must be less than 1/4" or a finger entrapment could exist.

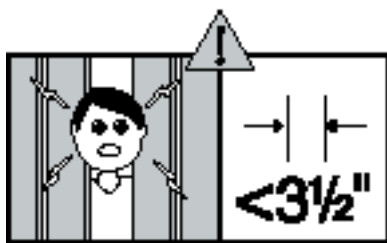

CAUTION: Spacing between boards must be less than 3 1/2" (or greater than 9") or a head/neck entrapment could exist.

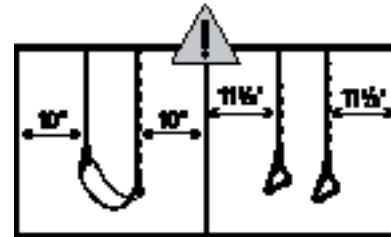

CAUTION: Minimum spacing is required from the closest point of all other rides or stationary objects.



CAUTION: Use wrench to tighten Quick-Link Connectors. Failure to tighten Quick-Links securely could result in injury.



CAUTION: Use two people to rotate, lift or support structure at this step to avoid injury to yourself or bending of brackets.

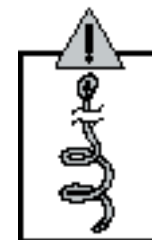

CAUTION: Failure to anchor properly could cause serious injury. Anchors must be placed below the level of the shock-absorbing surfacing material to prevent tripping or injury resulting from a fall. Refer to the Safety Guidelines at the beginning of this plan. **Note: If soil conditions permit anchors to be pulled out easily, such as in sandy soil conditions, cementing is required. If your ground is too hard to screw in the anchors you can remove the earth with a shovel. Install the anchors and compact the earth as you replace it.**

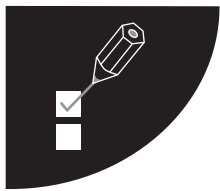

(24) **FP 2159**



(0) **SA 4496**



(1) **LT 7000**



(4) **FC 3217**

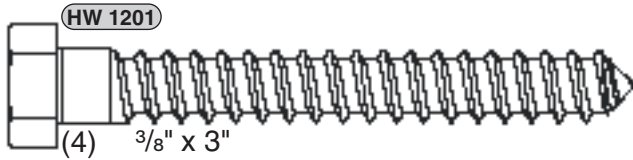
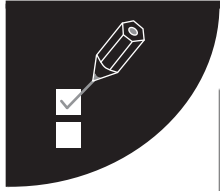

HW 1201
(4) $\frac{3}{8}$ " x 3"

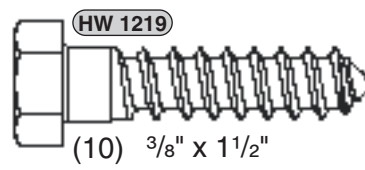

HW 1219
(10) $\frac{3}{8}$ " x 1 1/2"

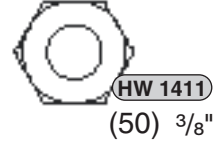

HW 1411
(50) $\frac{3}{8}$ "

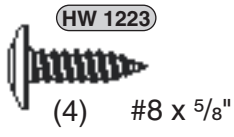

HW 1223
(4) #8 x 5/8"

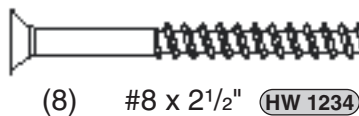

(8) #8 x 2 1/2" **HW 1234**

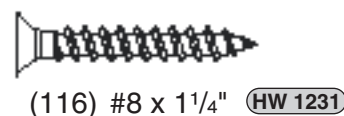

(116) #8 x 1 1/4" **HW 1231**



HW 1527
(32) $\frac{3}{8}$ " x 3 1/2"

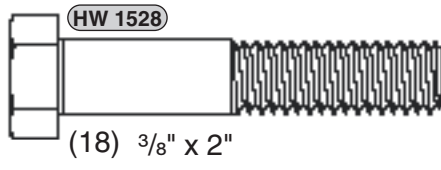

HW 1528
(18) $\frac{3}{8}$ " x 2"

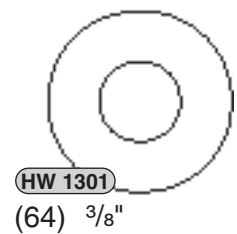

HW 1301
(64) $\frac{3}{8}$ "

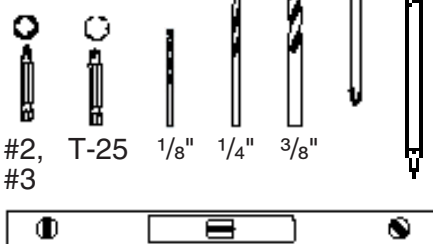
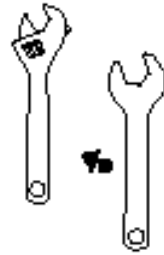
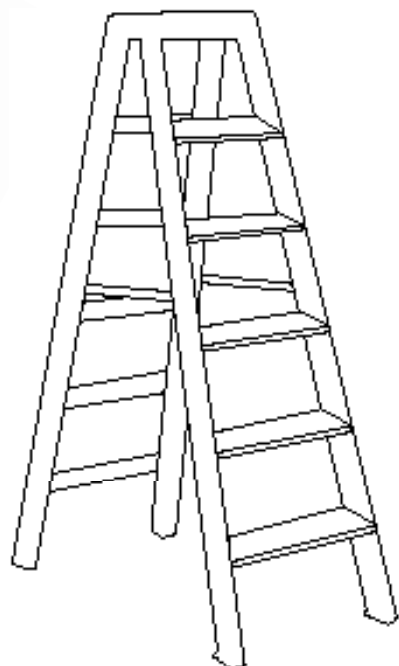
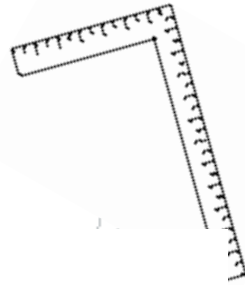
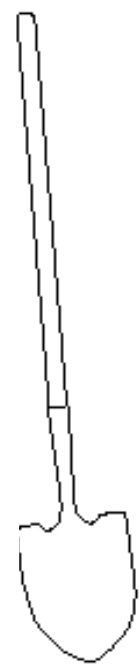
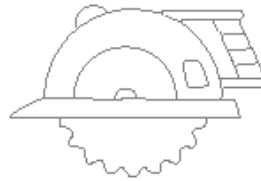
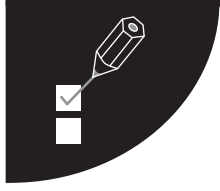

#2, T-25, #3
1/8", 1/4", 3/8"



Outer Monkey Rings & Bars Additional Hardware - Silver Only

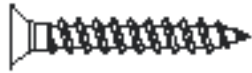

(20) #8 x 1 1/4" HW 1231

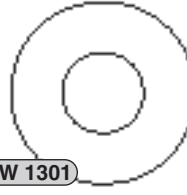

HW 1301
(44) 3/8"



HW 1411
(20) 3/8"

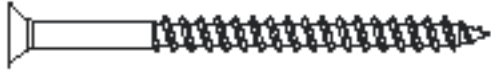

(4) #8 x 2 1/2" HW 1234



(4)
SA 4495



(4) FC 3217

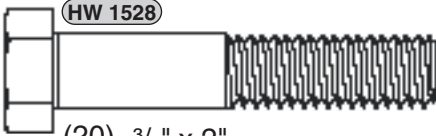

HW 1528

(20) 3/8" x 2"

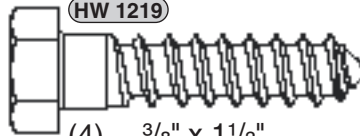

HW 1219

(4) 3/8" x 1 1/2"



Safety Plaque



HW 1223

(4) #8 x 5/8"



(1) LT 7000

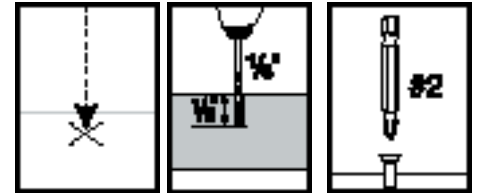

Place in prominent location on Cliffhanger structure.

Monkey Rings

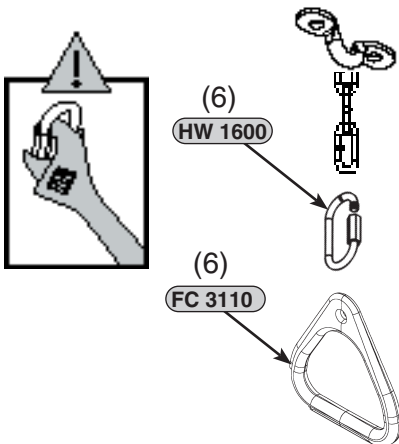

Play Handles

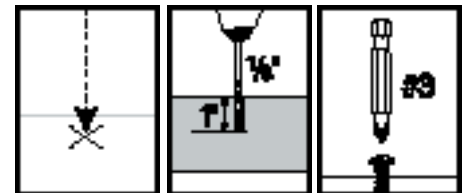
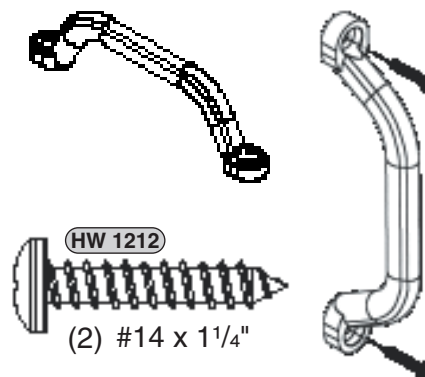



Add Brackets to Climbing Walls - All Design Options



Gold Design Option involves building two climbing towers. (You will repeat most steps using double the hardware listed.)

1



(2) PP 2199



HW 1411
(2) 3/8"



HW 1301
(2) 3/8"

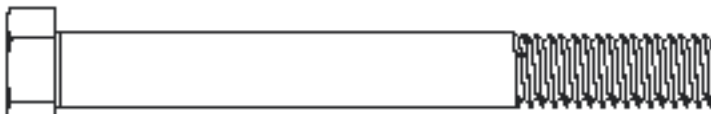

(2) 3/8" x 3 1/2" HW 1527

(1)

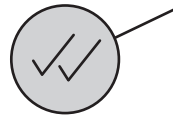
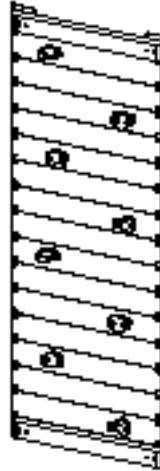

Each wall will be marked on the end. Be sure this end is used as the bottom of the wall.

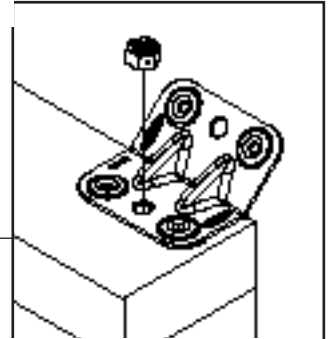

Install brackets on the right hand side of the wall.

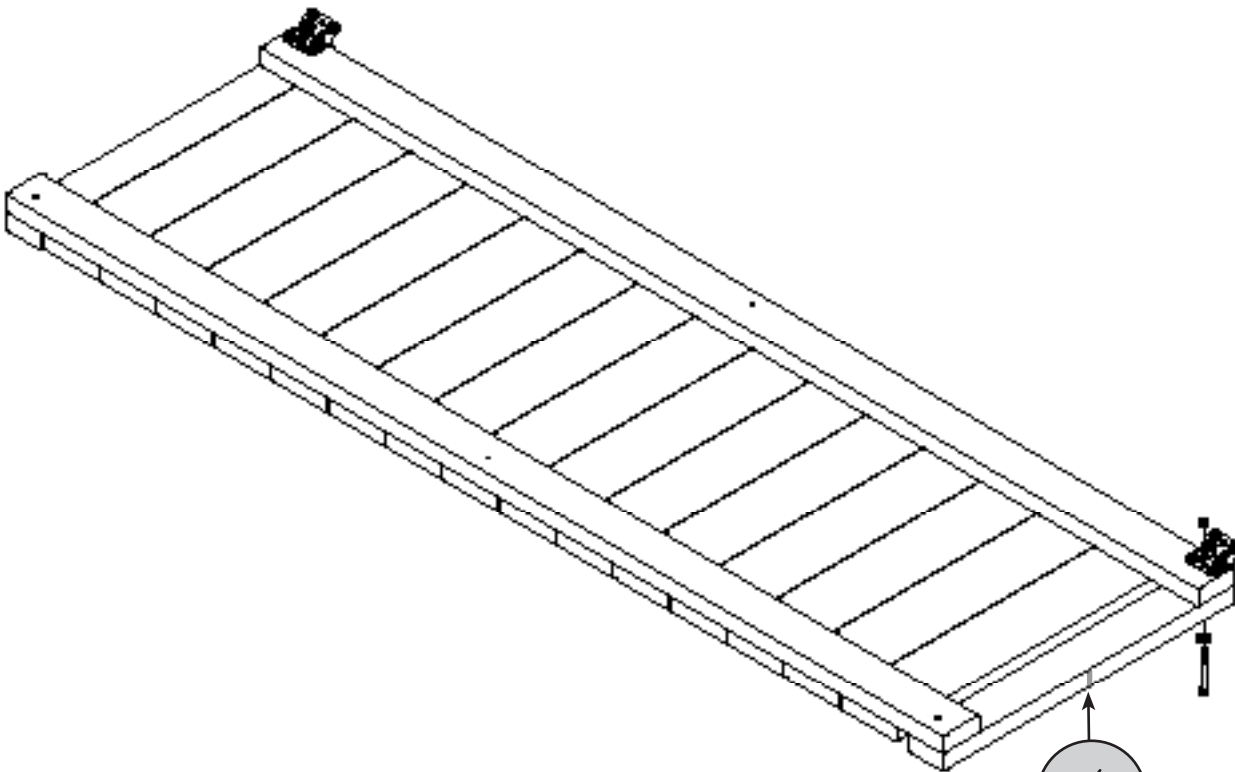

BOTTOM END

GOLD Design Option 2x

2

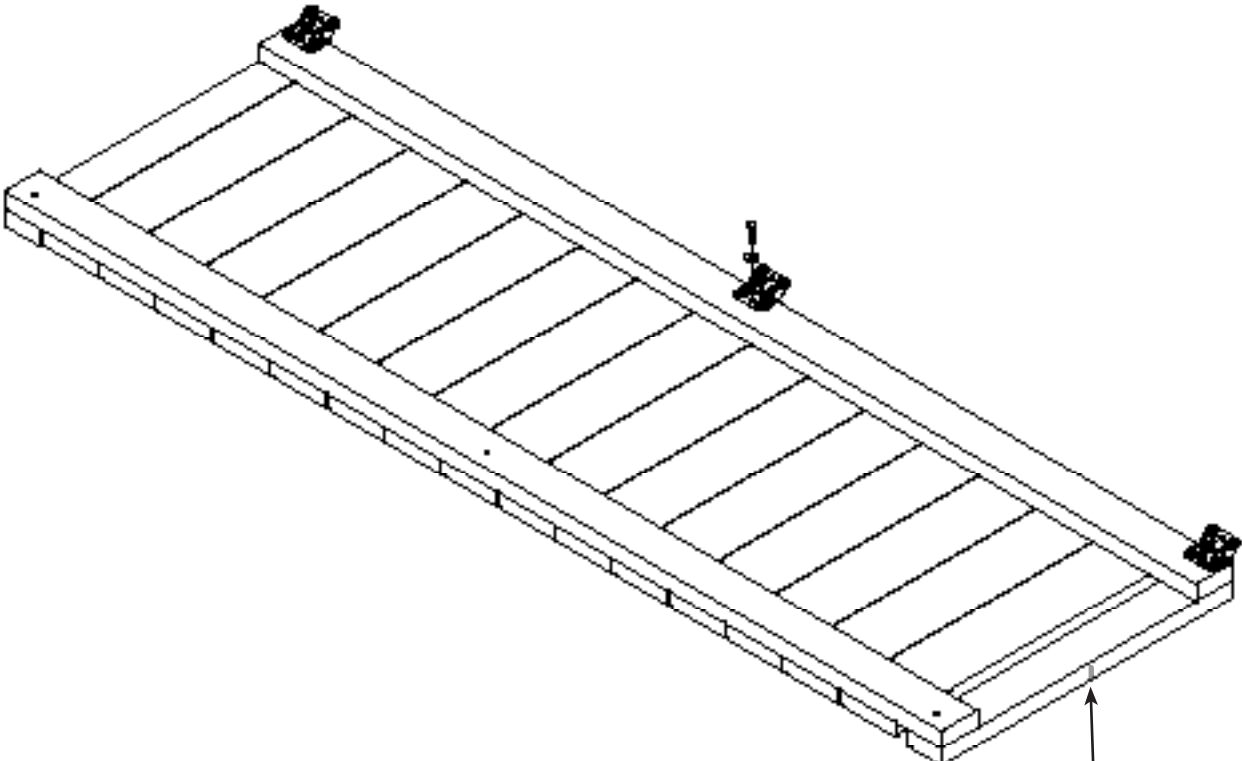
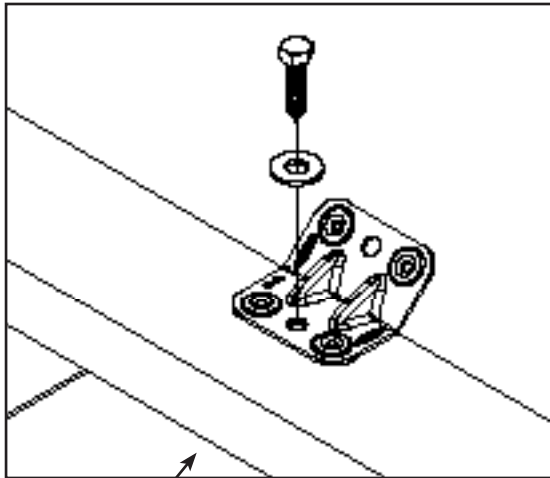
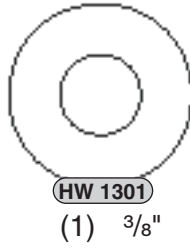
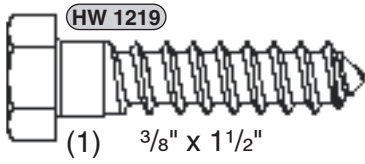

2x

BOTTOM END

3

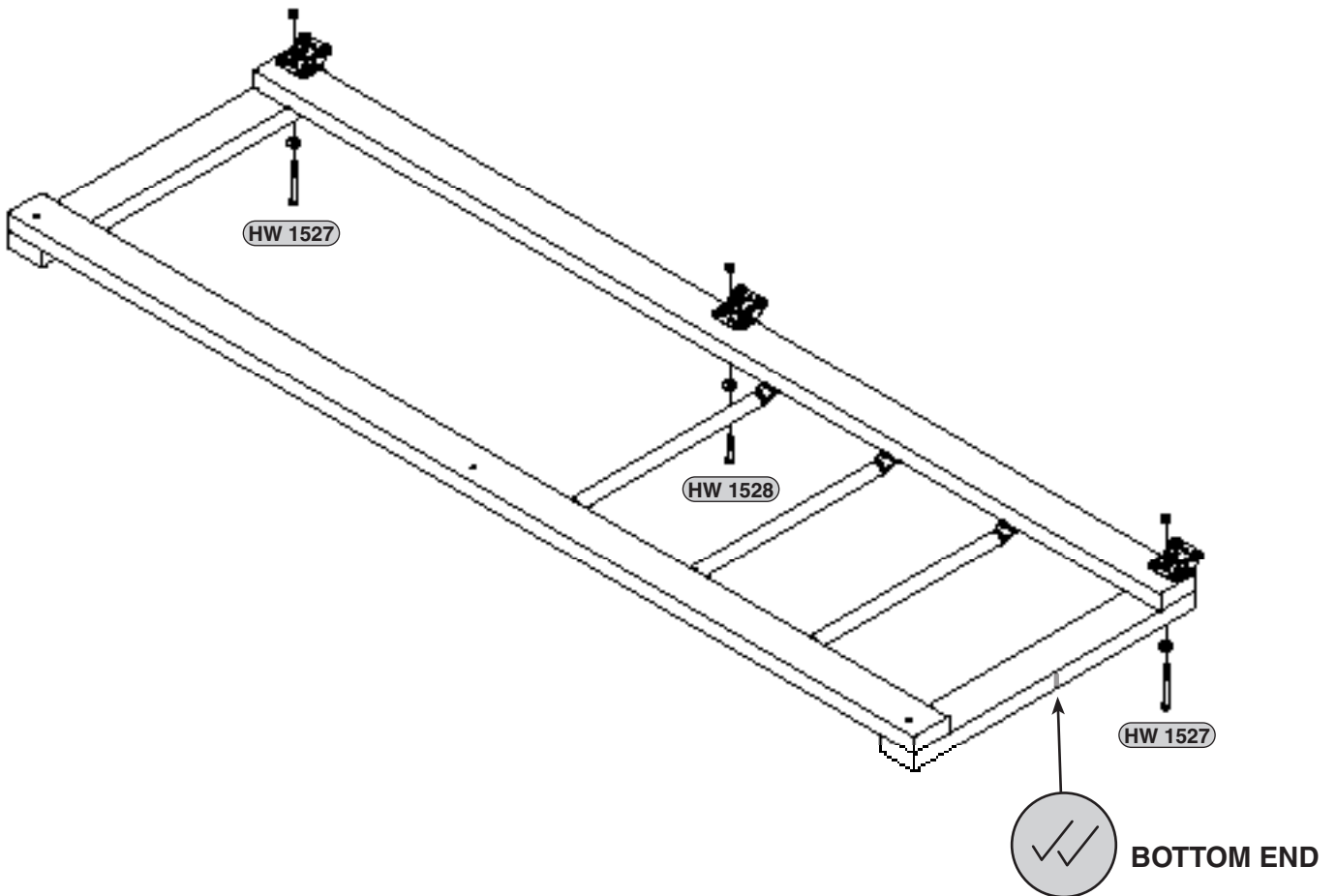
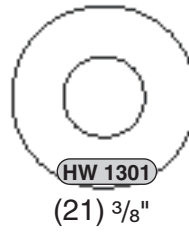
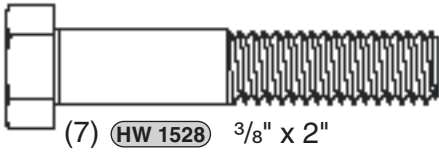

Repeat until all walls have brackets.



Combine Walls- All Design Options

1

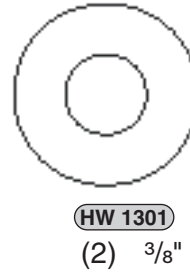
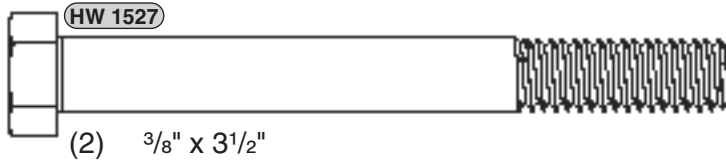

Start with the Full Rock Wall and attach any other climbing wall of your choice.

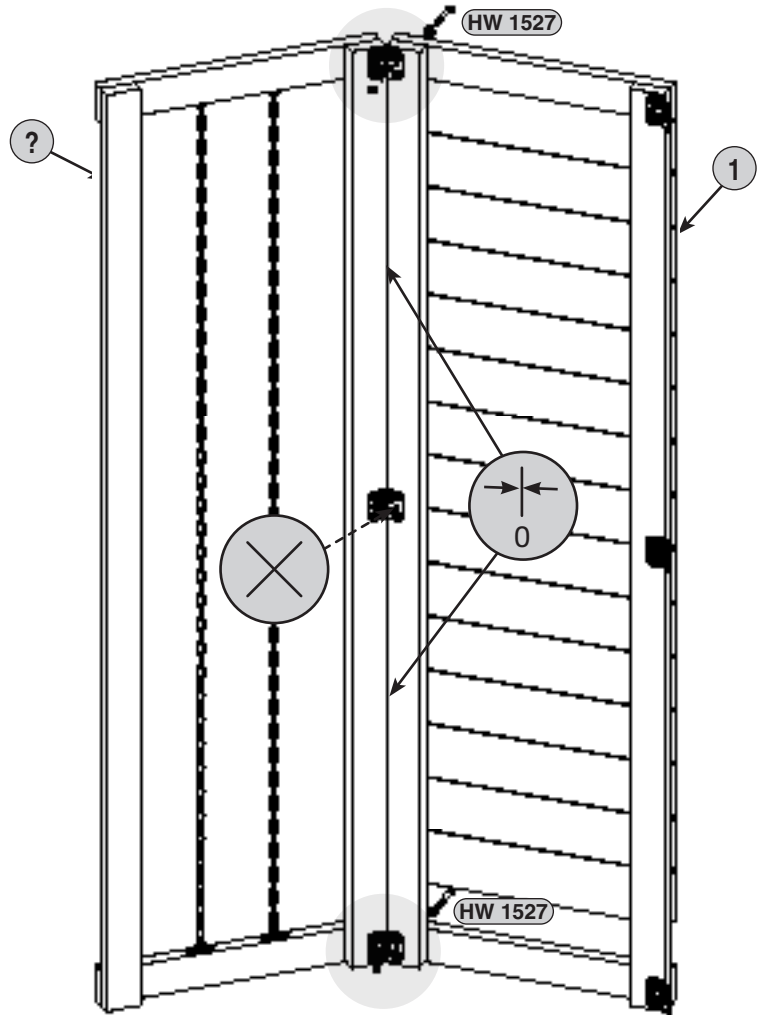

2

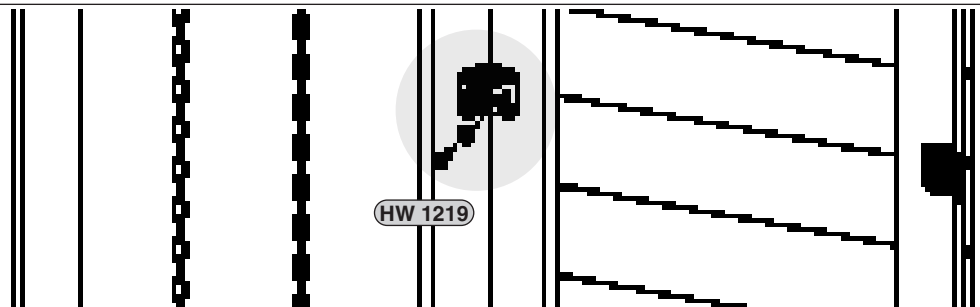
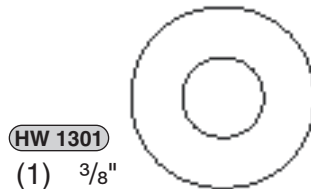
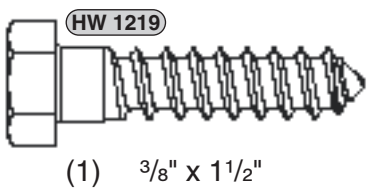

3



(14) 3/8" x 3 1/2"

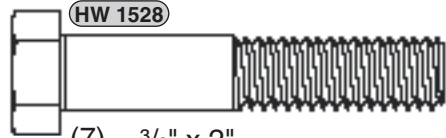

(7) 3/8" x 2"



(21) 3/8"

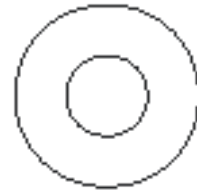

(21) 3/8"

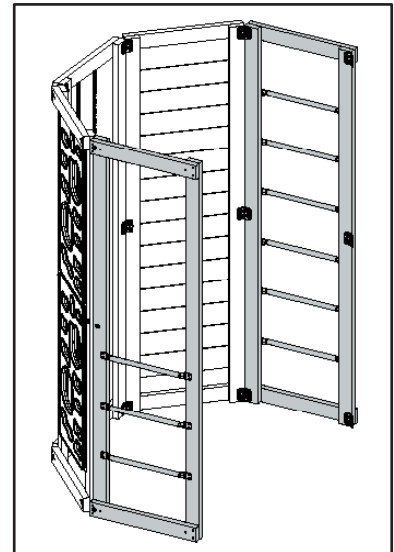
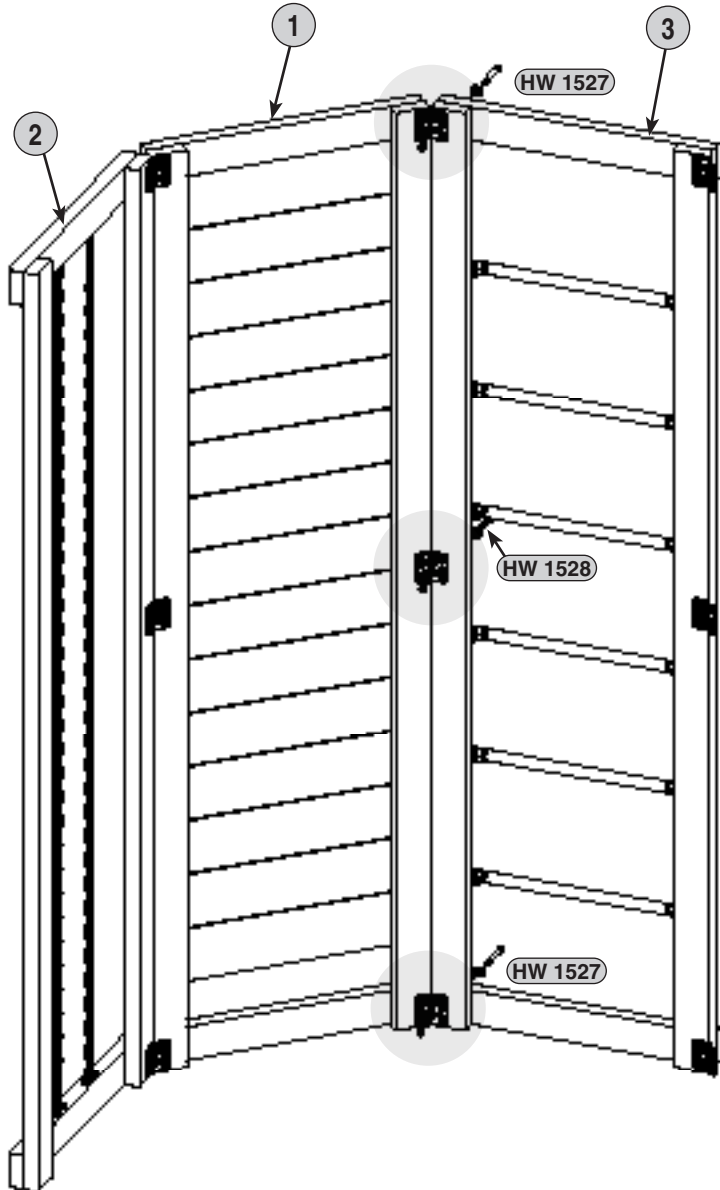

Continue repeating Step 3 until entire octagon climbing structure is completed.

ONLY requirement: The two walls containing climbing bars must be placed directly across from one another.



1x



2x

4

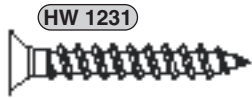

(96)#8 x 1 1/4"

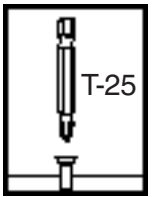
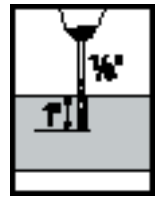

T-25

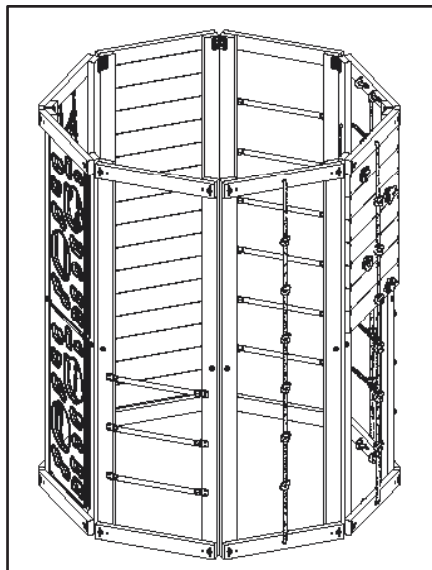
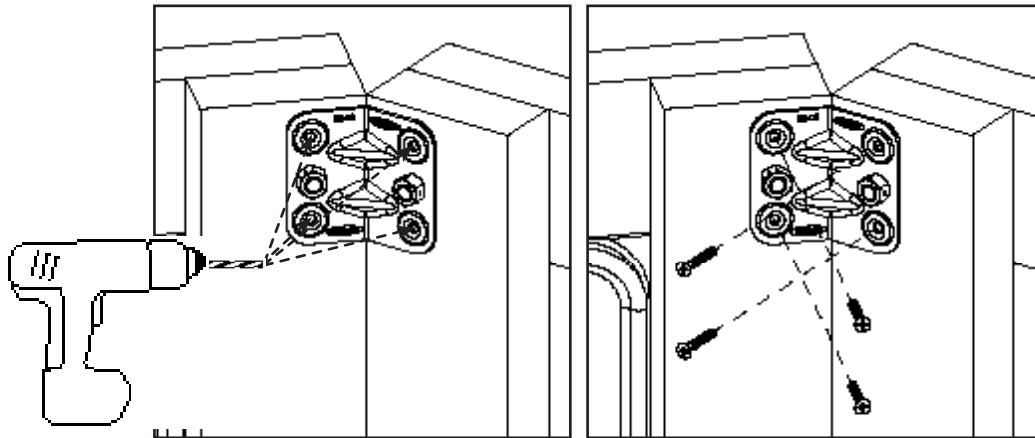

Continue repeating Step 4 until all brackets are secured with screws.

  1x
 2x



Inner Monkey Rings- All Design Options

1

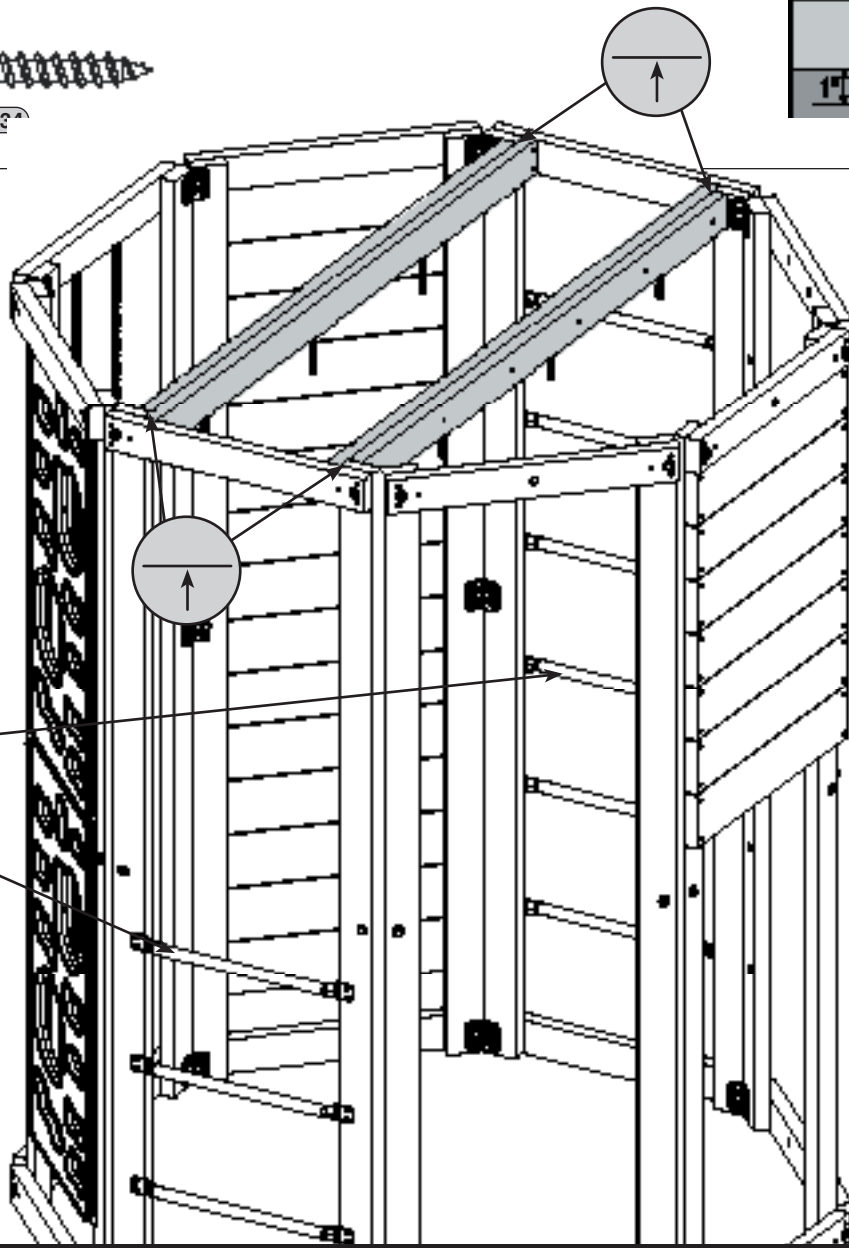
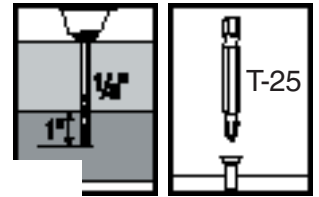
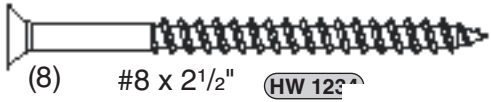

Attach Monkey Rings between the two walls with climbing bars.



2

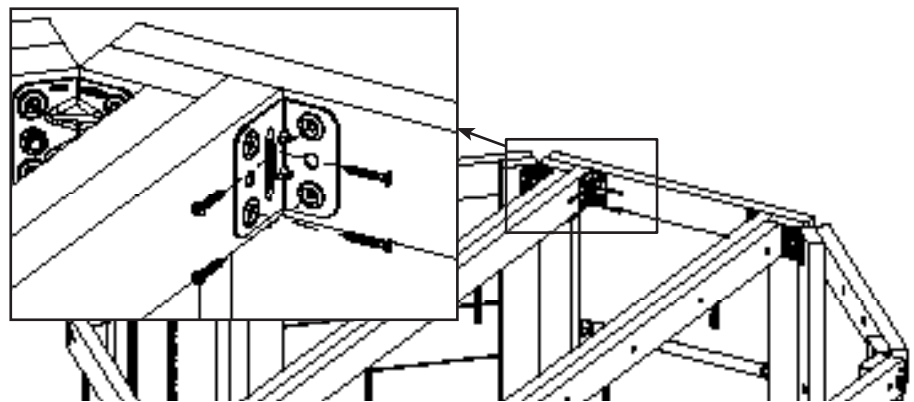
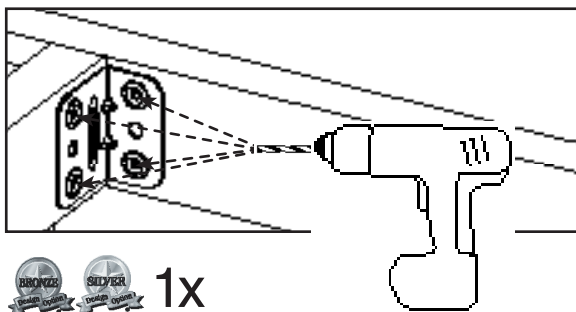
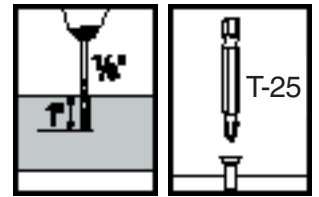
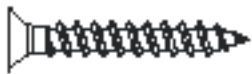

3

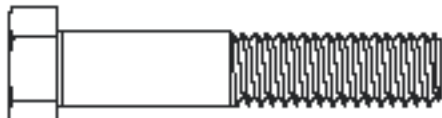

(4) HW 1528 3/8" x 2"

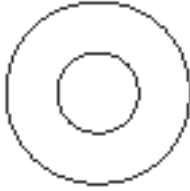

HW 1301

(4) 3/8"



HW 1411

(4) 3/8"

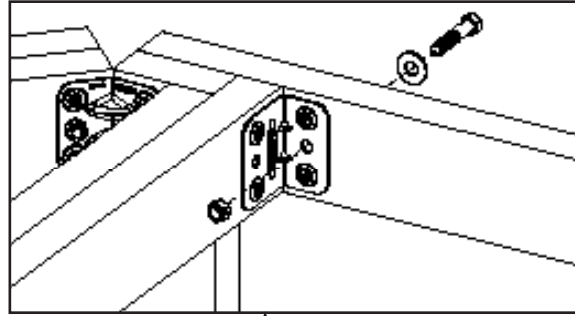
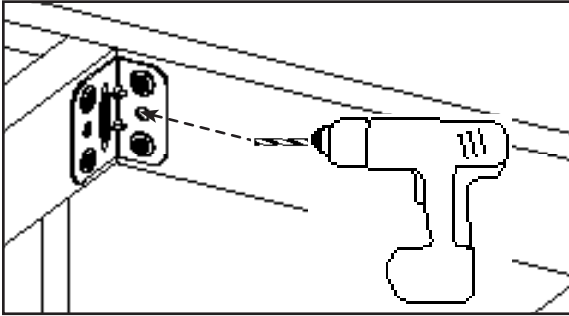
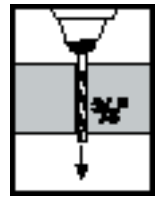

BRONZE 1x
SILVER
GOLD 2x

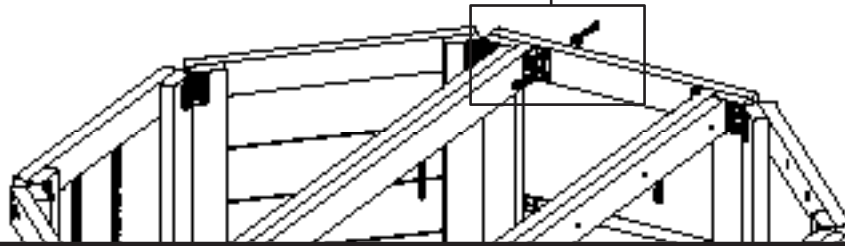

4

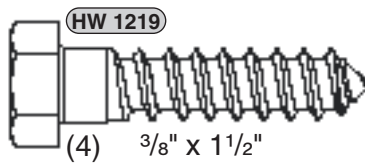

(4) HW 1219 3/8" x 1 1/2"

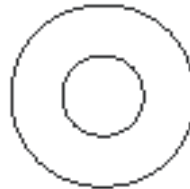

HW 1301

(4) 3/8"

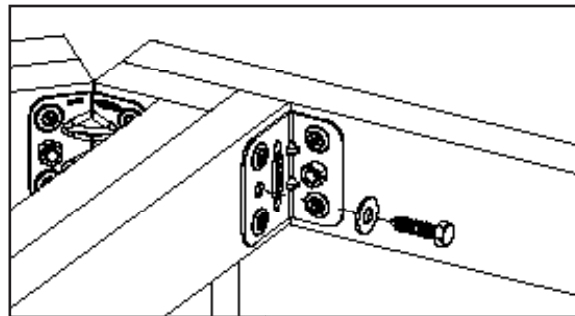
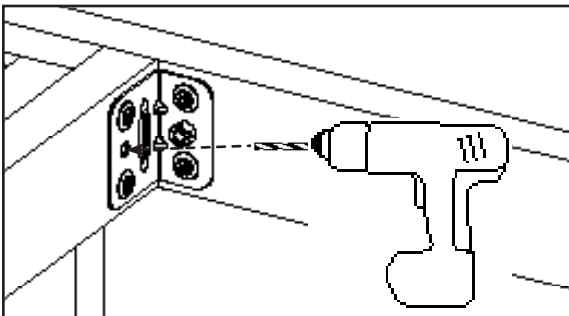
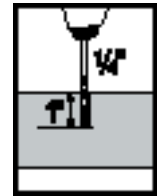

BRONZE 1x
SILVER
GOLD 2x





Anchoring- Bronze Design Only



(4) FC 3217

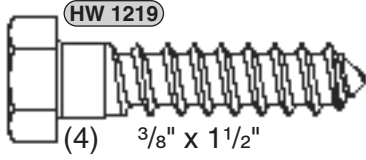

HW 1219

(4) 3/8" x 1 1/2"

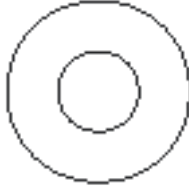

HW 1301

(4) 3/8"

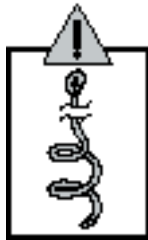
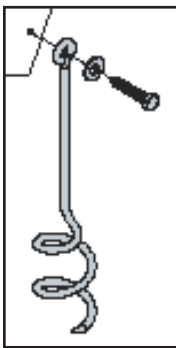
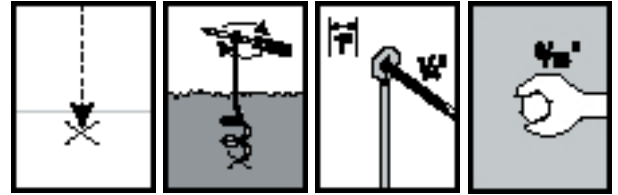

Alternate anchors on every other wall.

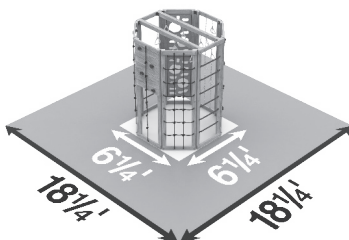
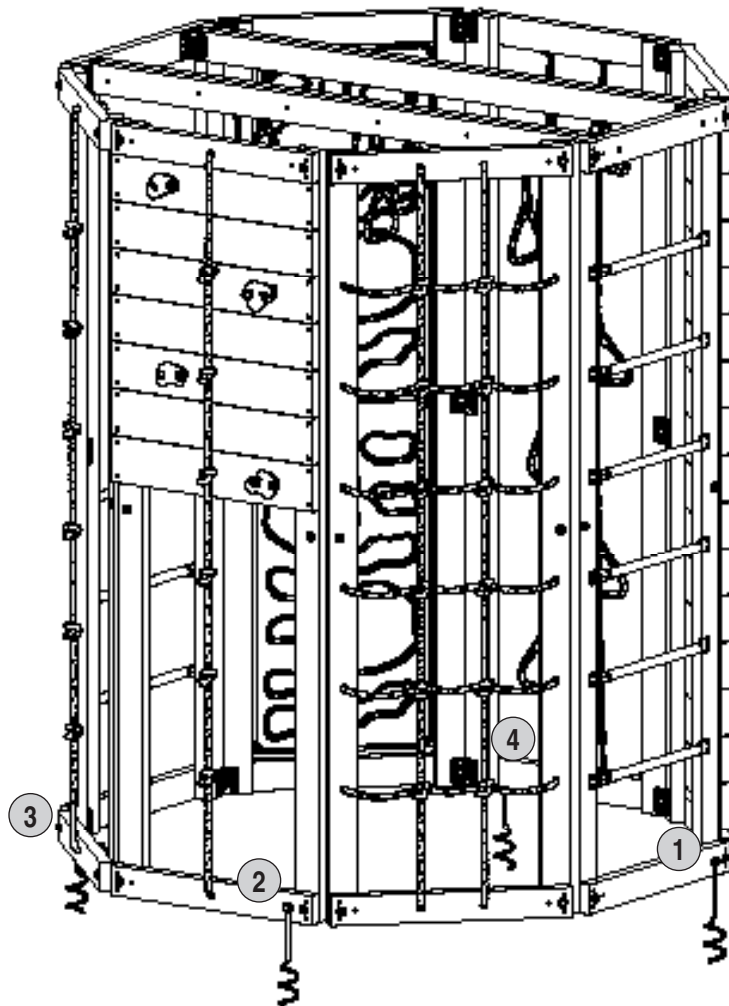



Outer Monkey Rings & Bars Assemblies

1



(20) HW 1411
3/8"

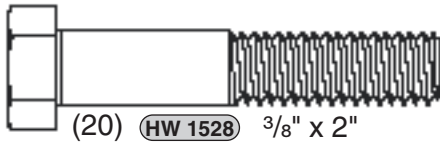

(20) HW 1528 3/8" x 2"

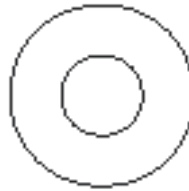

(40) HW 1301
3/8"

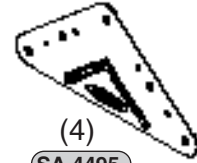

(4) SA 4495

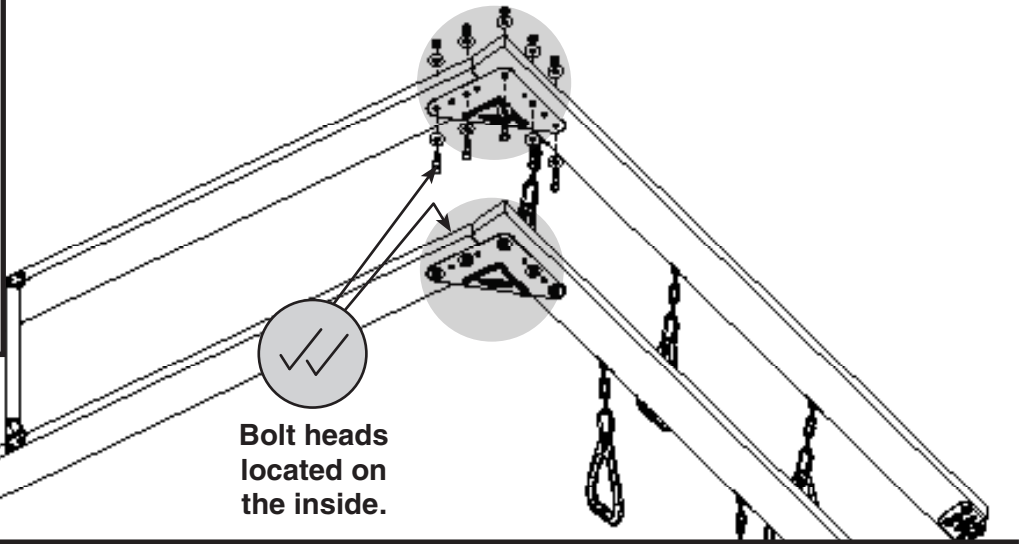
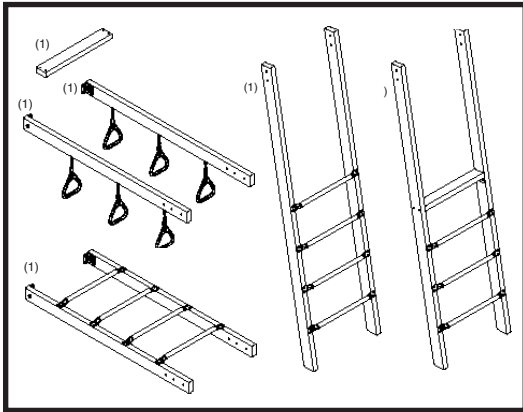

✓
Bolt heads located on the inside.

2



(16) HW 1231
#8 x 1 1/4" TRX

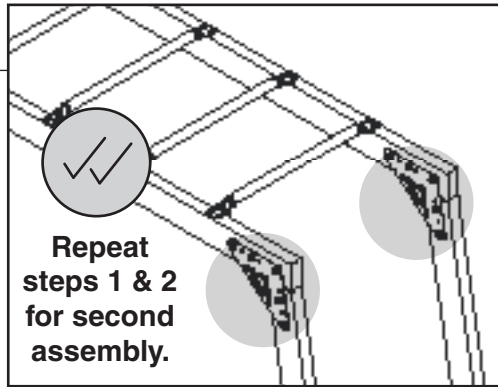
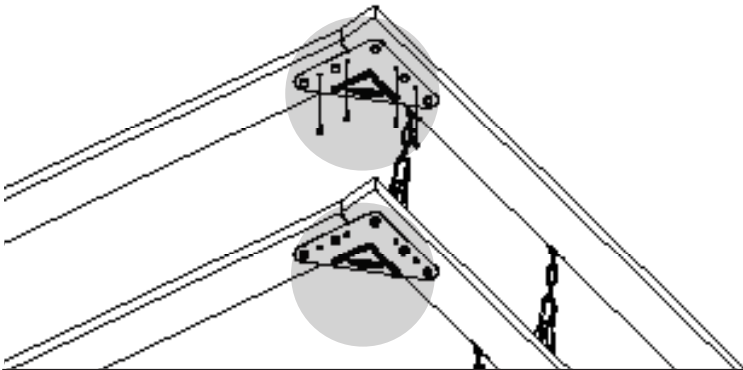
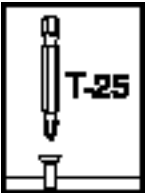

✓
Repeat steps 1 & 2 for second assembly.

3



(4) #8 x 2 1/2"

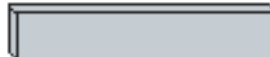

(1) 2" x 4" x 24 1/2"

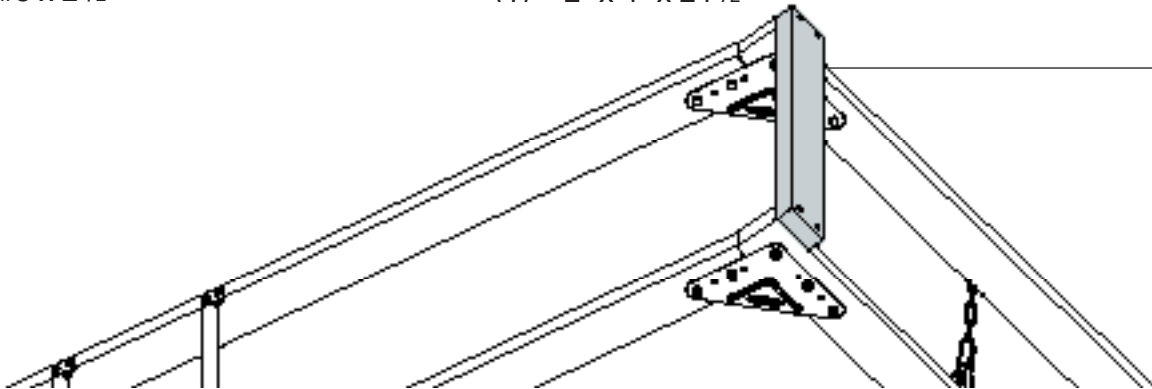
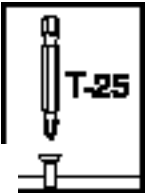

HW 1231

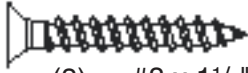

(8) #8 x 1 1/4" TRX

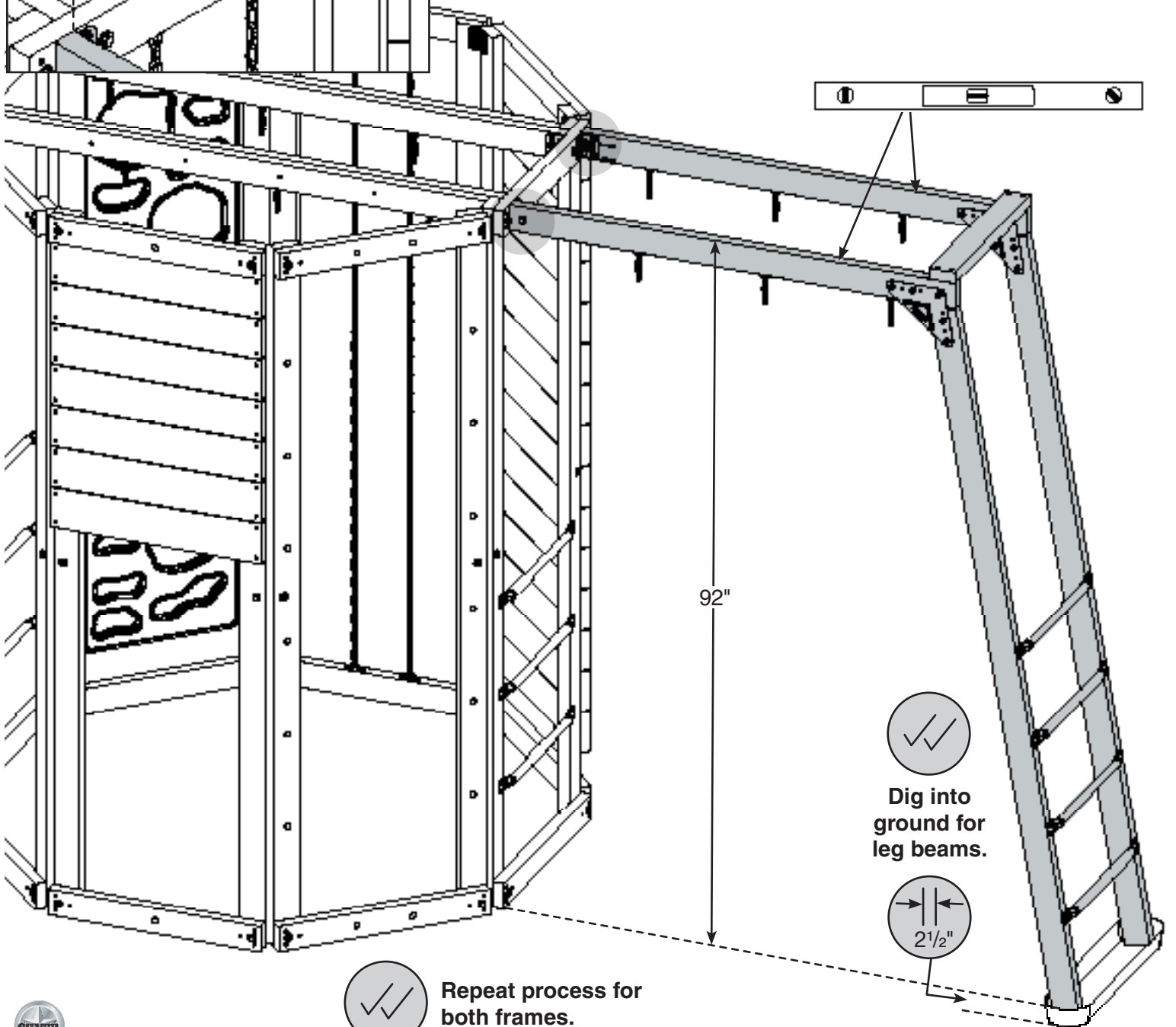
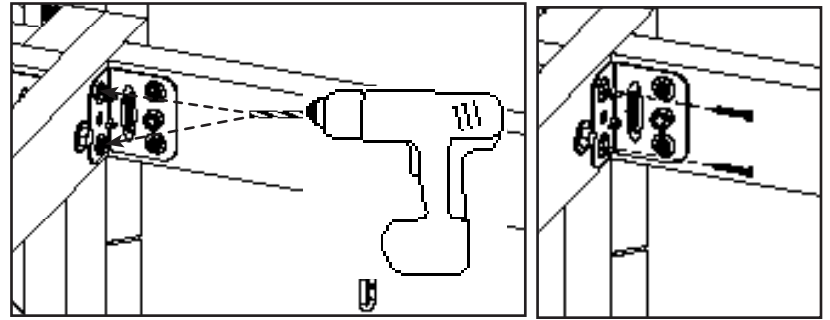
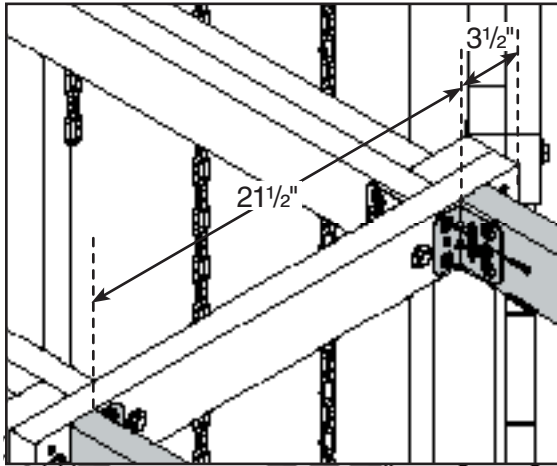
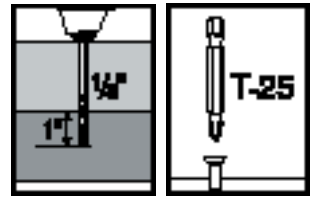

5

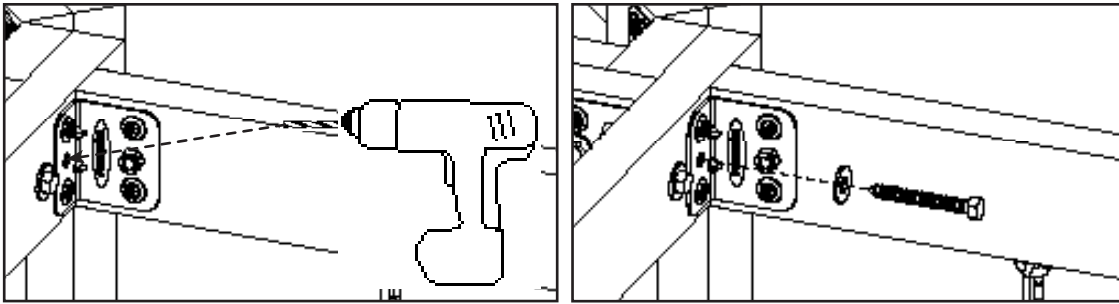
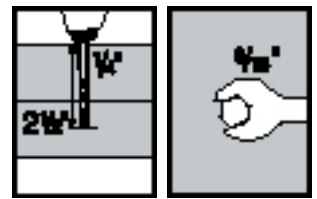
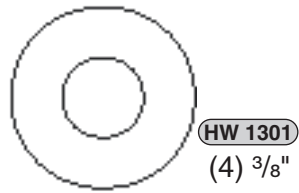
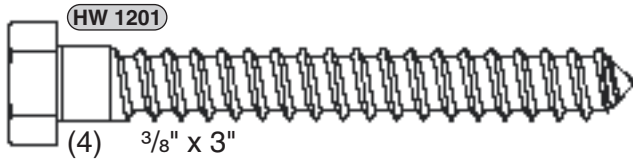

Repeat process for both frames.

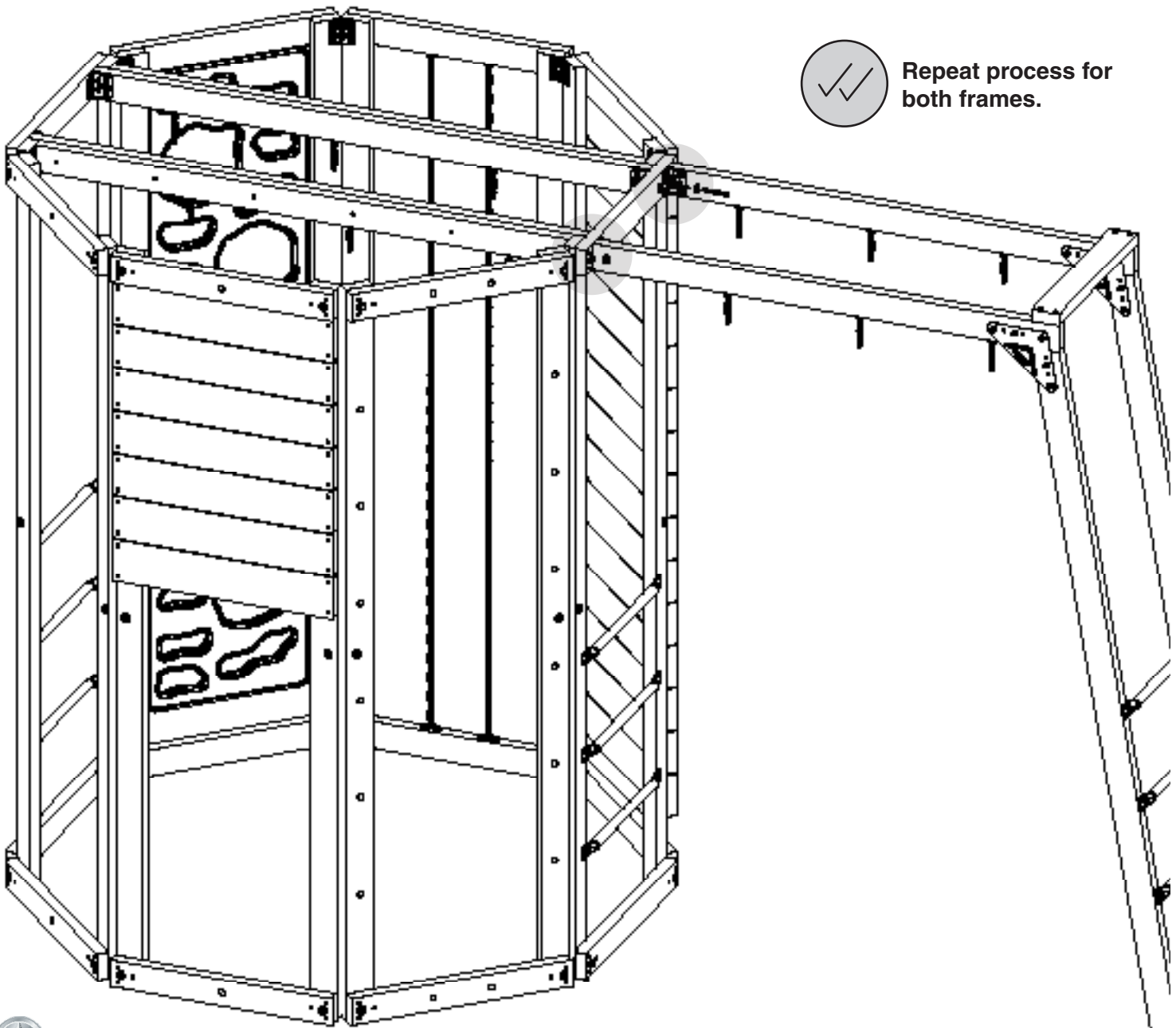



Anchoring- Silver Design Only



(8) FC 3217

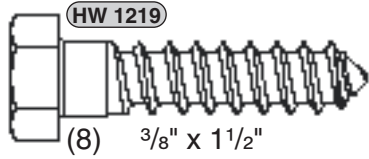

HW 1219
(8) 3/8" x 1 1/2"

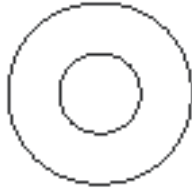

HW 1301
(8) 3/8"

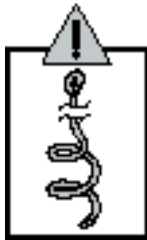
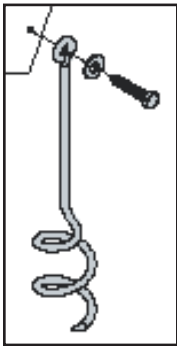
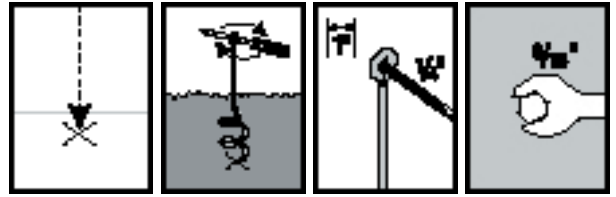

Alternate anchors on every other wall.

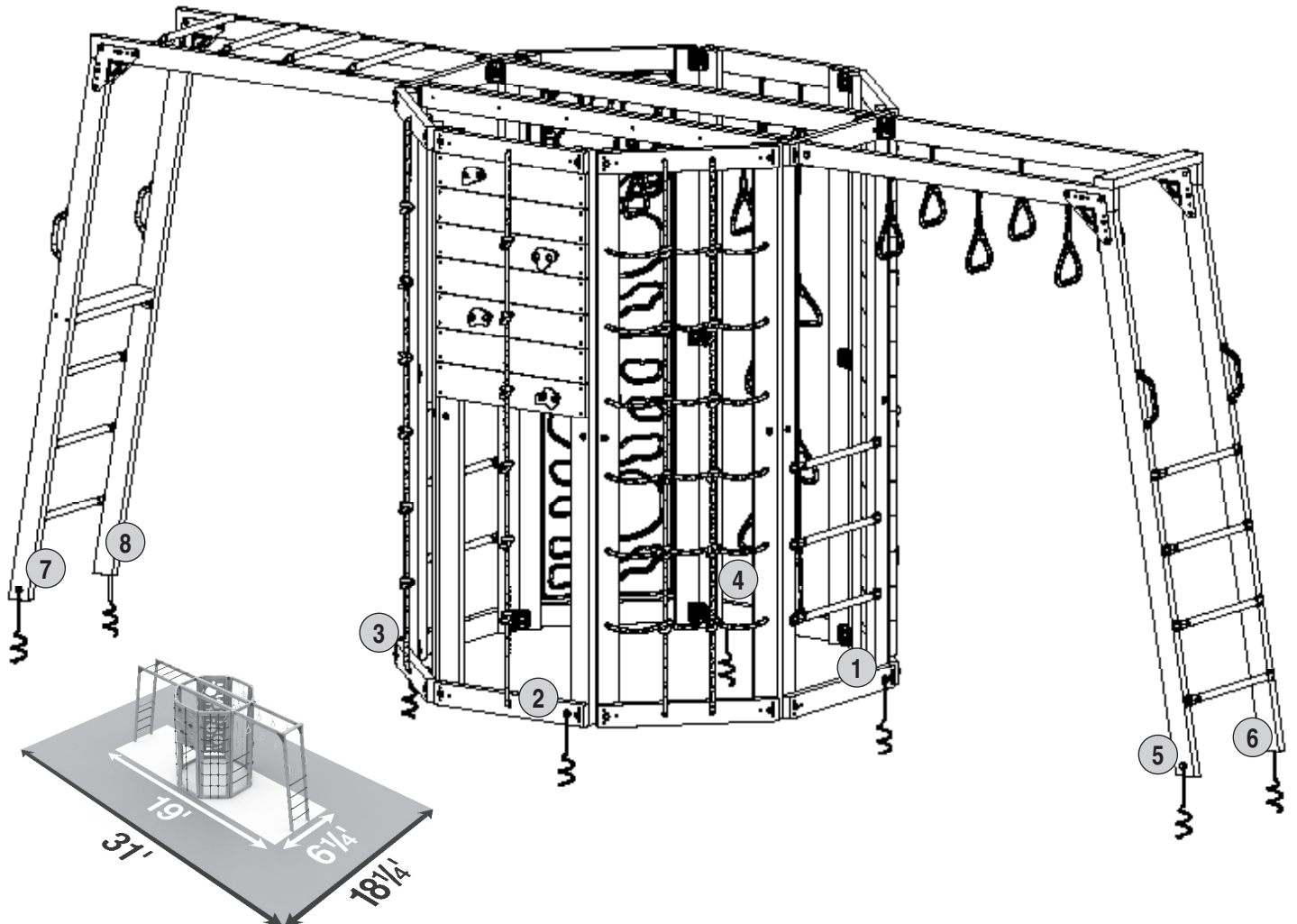



Connector Monkey Ring Assemblies

1

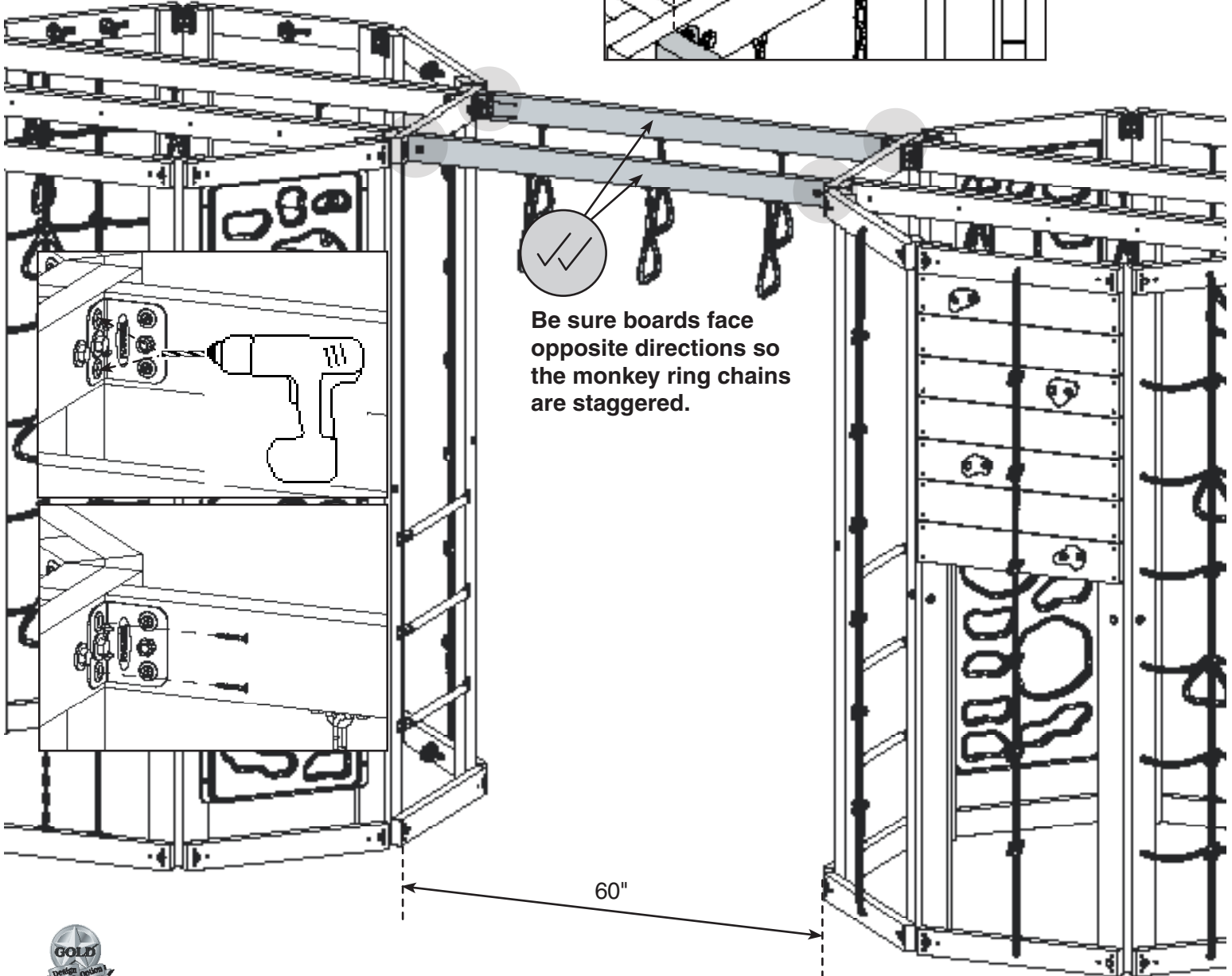
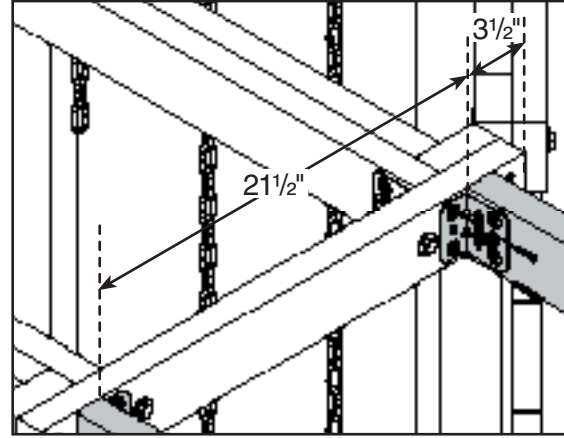
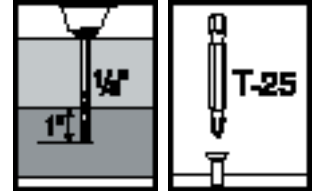
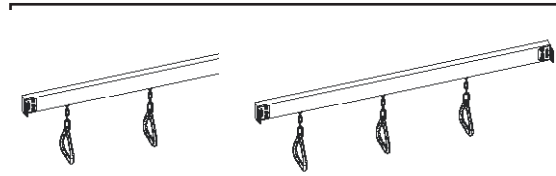
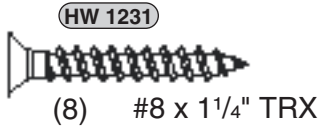

2

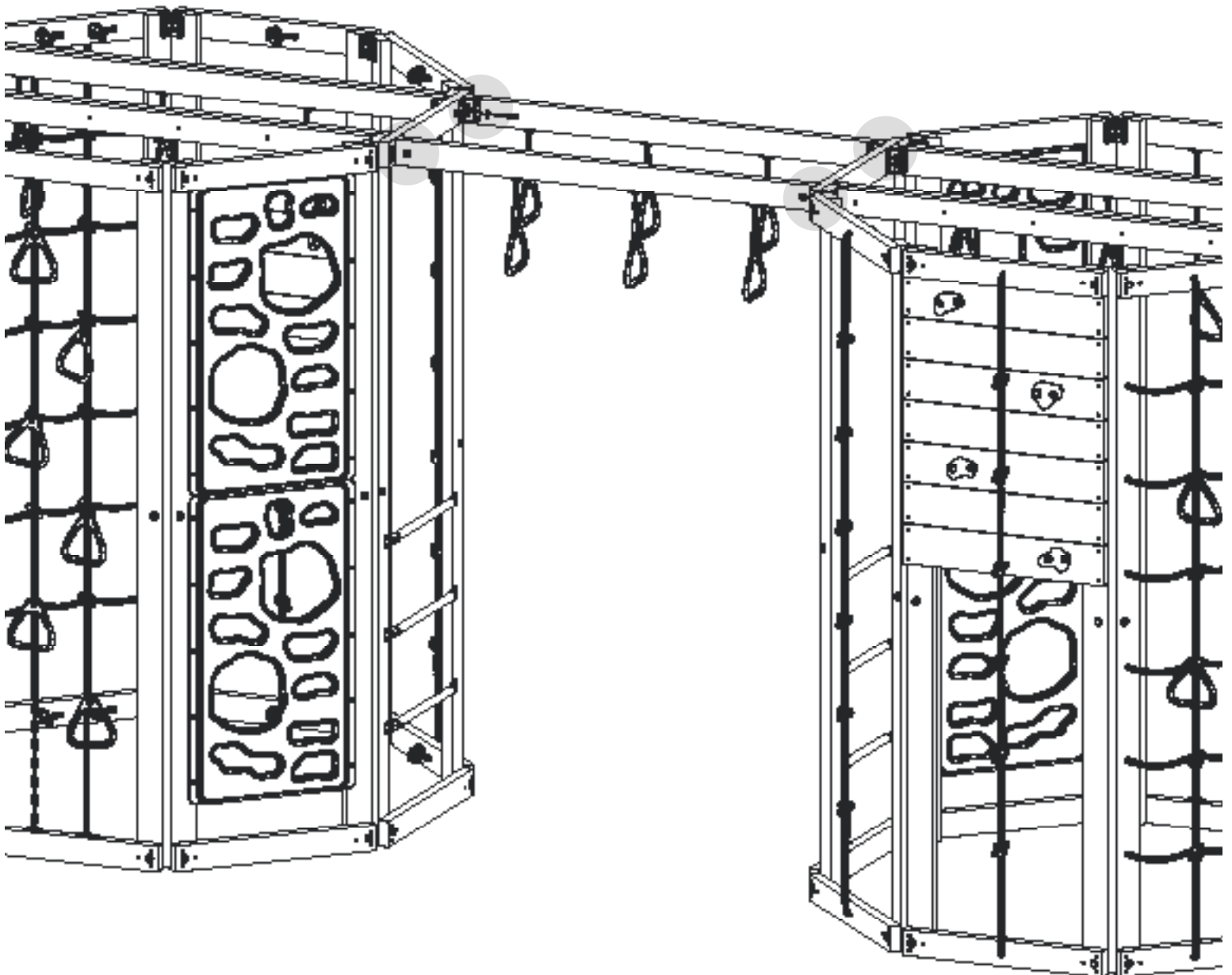
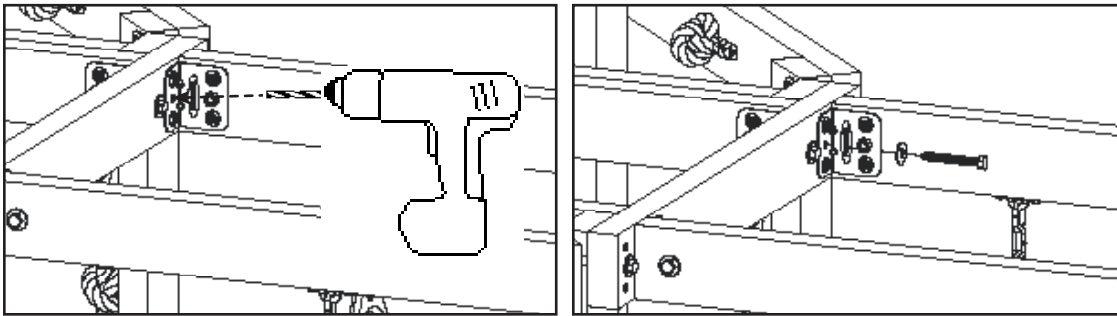
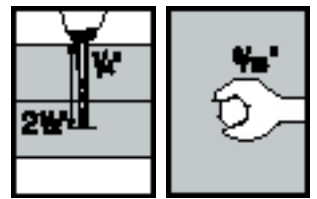
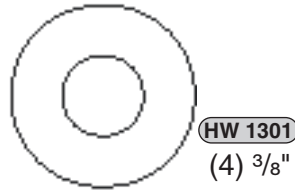
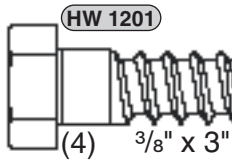



Anchoring - Gold Design Only



(8) FC 3217

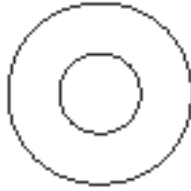
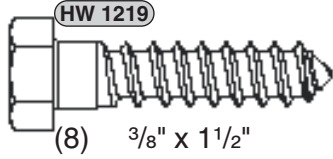

HW 1301
(8) 3/8"

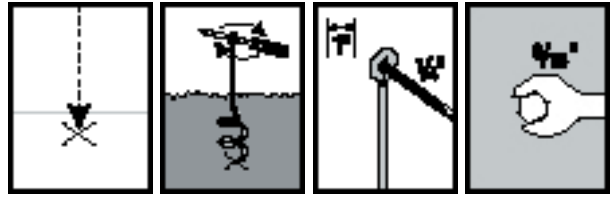

Alternate anchors on every other wall.

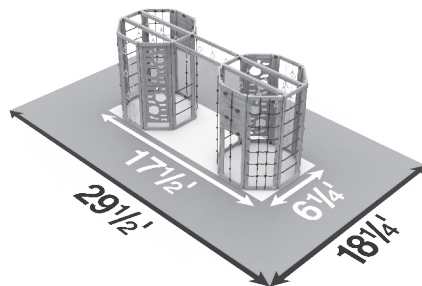
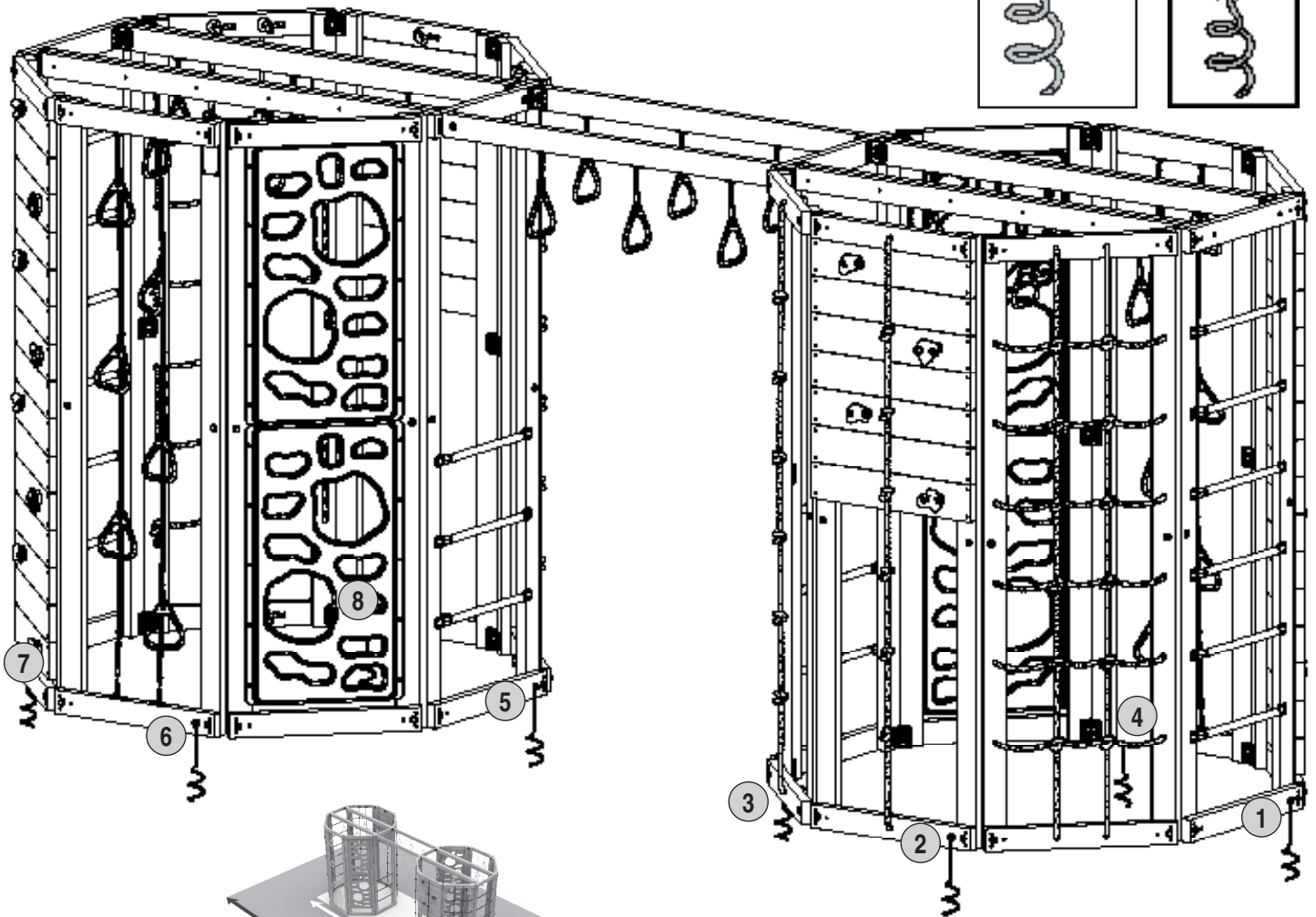
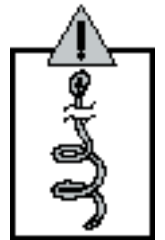
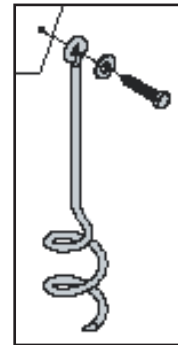



www.playstarinc.com

Thank you for choosing PlayStar

Questions, Concerns or Missing Parts? Please contact us for assistance!
Register your PlayStar product at: playstarinc.com/playstar-warranty

1-888-PLAYSTAR (752-9782) custserv@playstarinc.com
Monday through Friday, 8:00 A.M. to 5:00 P.M. C.S.T.

Gracias por escoger PlayStar.

No lo devuelva a la tienda ¡Póngase en contacto con nosotros para ayudarlo!
Registre su producto PlayStar en: playstarinc.com/playstar-warranty

1-888-PLAYSTAR (752-9782) custserv@playstarinc.com
De Lunes a Viernes de 8:00 A.M. a 5:00 P.M. C.S.T.

Merci d'avoir choisi Playstar.

Des questions, des préoccupations ou des pièces manquantes ? Veuillez nous contacter pour obtenir de l'aide !
Enregistrez votre produit PlayStar à: playstarinc.com/playstar-warranty

(450) 699-3083 custserv@playstarinc.com
Du lundi au vendredi, de 8 h à 16 h E.S.T.

PlayStar, Incorporated, Janesville, WI 53547

© 2022, 2021, 2017 PlayStar, Inc. Reproduction of this document in part or whole is prohibited without the permission of PlayStar, Inc.

Protected by one or more of the following United States or Foreign Patents: US D418,189; US D409,708; US D424,154; US D428,637; US 6,402,663; US D422,332; US D410,059; US 6,068,557; US 6,302,801; US 6,482,095; US 6,039,654; US D410,060; US D424,649; US 6,361,445; CA 2,304,345; US 6,540,645; US 6,709,365; US 6,942,600; US D513,779; US 6,991,550; CA D109,228; CA D109,224; CA D109,225; CA 2,304,113; US 6,629,907; US D517,636; US D518,530; US D520,590; US 520,591; US D534,613; US 7,186,183; US 7,189,034; US 7,253,951; US D548,760; US 7,304,810; CA D109,227; CA D109,226; CA D112,355; CA D113,437; CA D113,442; CA D114,067; CA D114,068; CA 2,304,896; CA D119,674; US D573,222; US 7,419,437; CA 2,304,068; CA 2,488,576; US D580,507; US D585,570; CA 2,490,923; CA 2,304,341; US 7,594,875; CA 2,304,043; CA 2,529,276; CA 2,633,628; CA 2,633,056; US 7,594,875; CA 2,498,701; CA 2,495,136; CA 2,488,600; CA 2,488,574